

OLYMPUS[®]

Your Vision, Our Future

MULTIPHOTON LASER SCANNING
MICROSCOPE

FV1000MPE

FLUOVIEW[®]

NEW

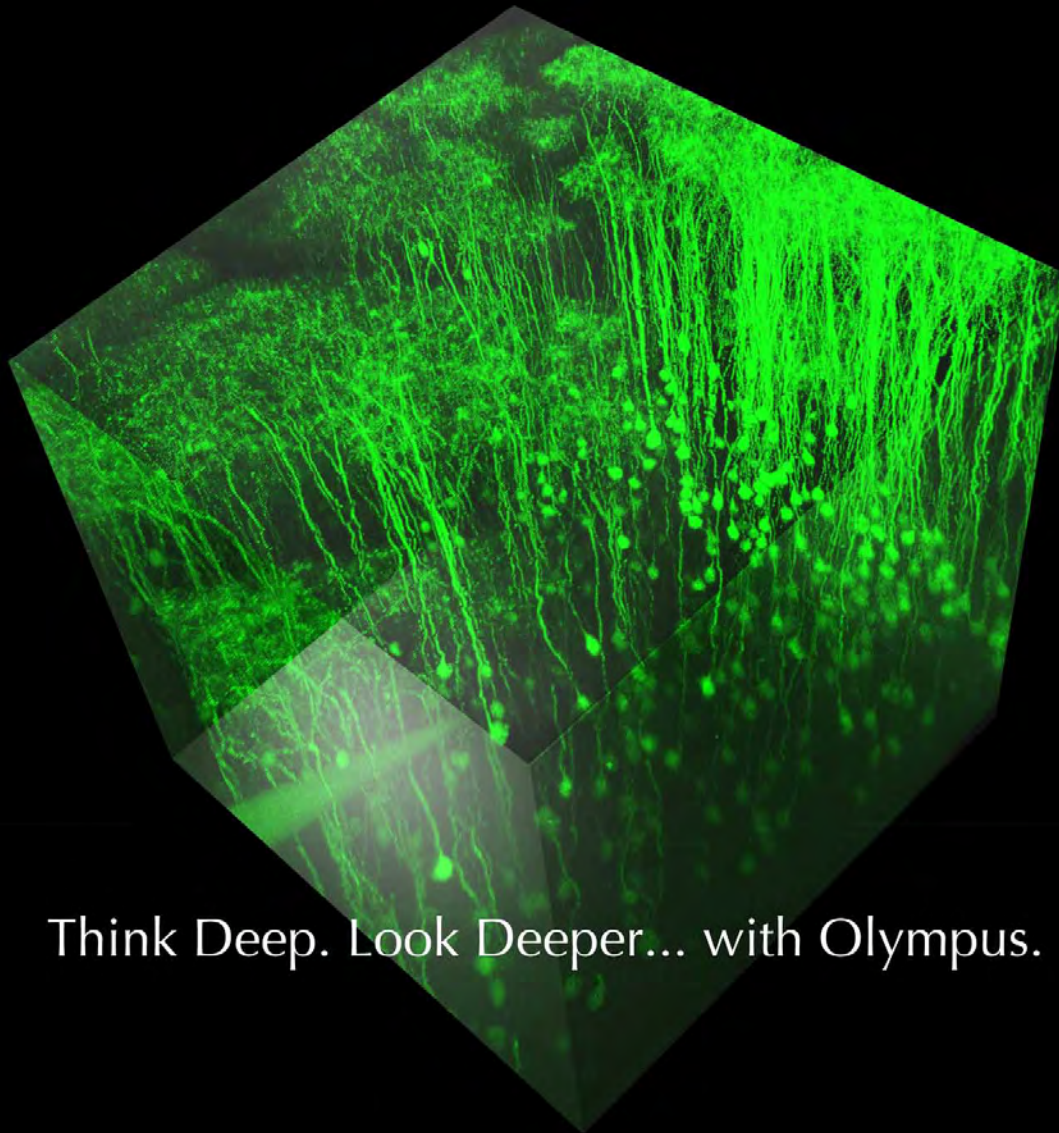

Think Deep. Look Deeper... with Olympus.



UIS2
World-leading optics

Brighter and deeper imaging with better resolution.

Olympus FV1000MPE multiphoton laser scanning microscope is renowned for its ability to offer bright, clear imaging deep within specimens. This is thanks to its optical design, which allows the microscope to faithfully produce the phenomenon of multiphoton excitation.

By closely adhering to optics principles and designing a microscope that is both compact and easy to use, Olympus developed the new FV1000MPE so all researchers can use the microscope to perform in-depth observation.

With its "brighter and deeper imaging with better resolution," the FV1000MPE opens up greater discovery.



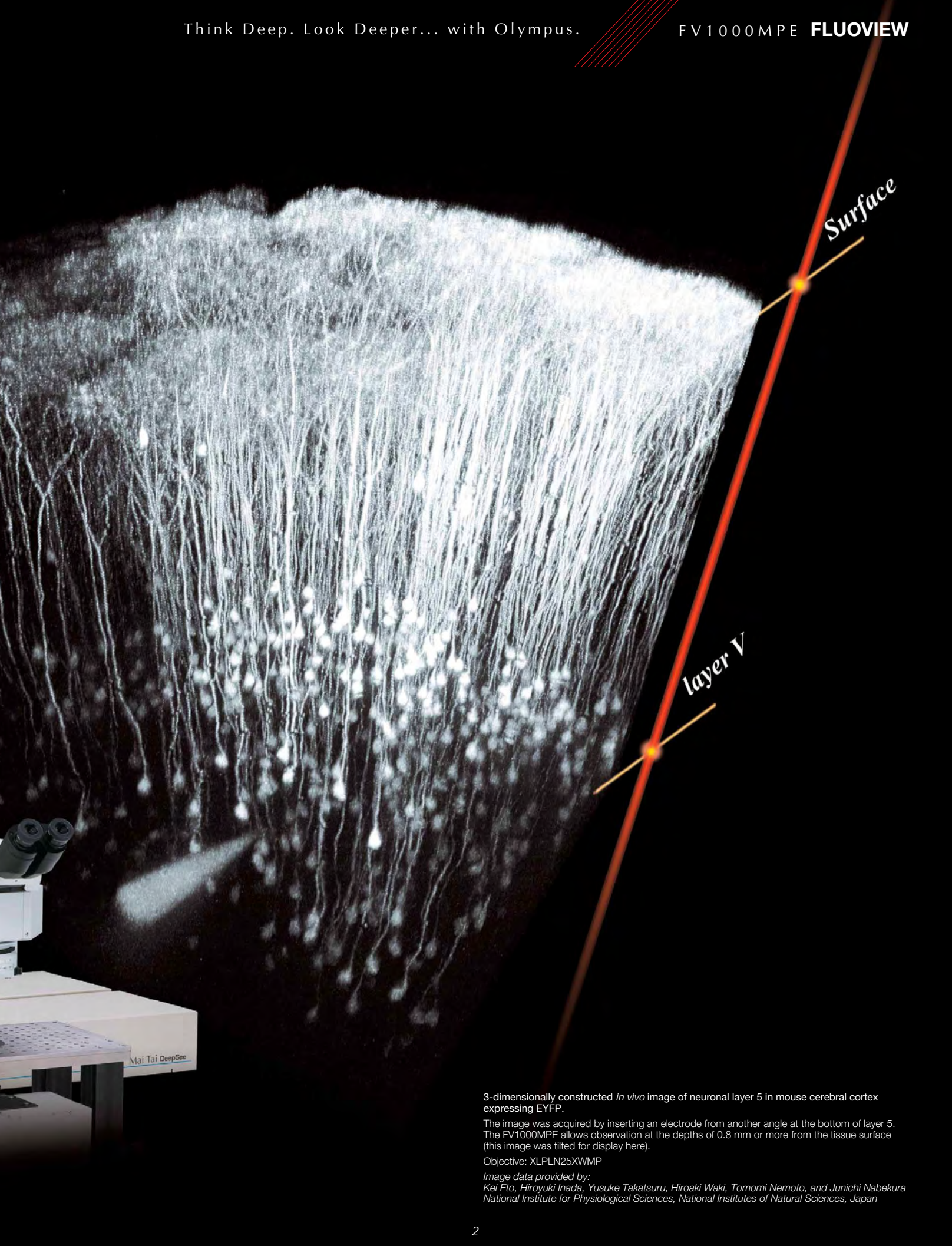

3-dimensionally constructed *in vivo* image of neuronal layer 5 in mouse cerebral cortex expressing EYFP.

The image was acquired by inserting an electrode from another angle at the bottom of layer 5. The FV1000MPE allows observation at the depths of 0.8 mm or more from the tissue surface (this image was tilted for display here).

Objective: XLPLN25XWMP

Image data provided by:
Kei Eto, Hiroyuki Inada, Yusuke Takatsuru, Hiroaki Waki, Tomomi Nemoto, and Junichi Nabekura
National Institute for Physiological Sciences, National Institutes of Natural Sciences, Japan

With multiphoton excitation adhering to optical principles, the FV1000M high-resolution observation deep within specimens without damaging

Laser unit IR pulsed laser with negative chirp for multiphoton excitation

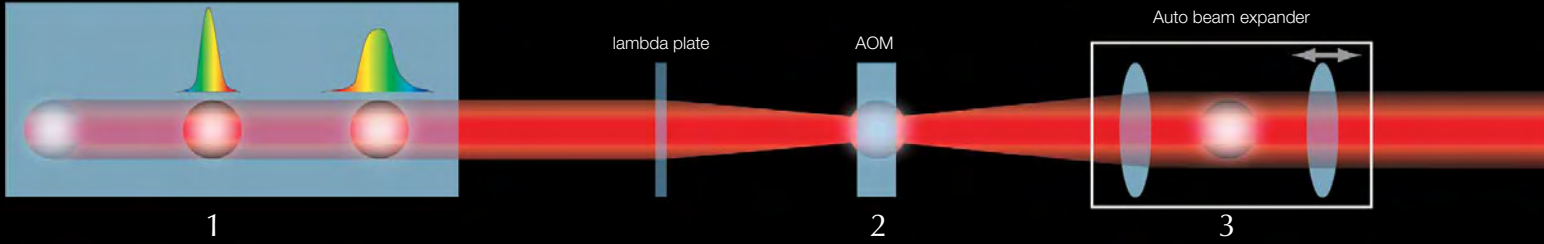

1 Brighter and deeper imaging with less damage.

In multiphoton microscopy, the excitation fluorescence efficiently is maximized efficiently by use of the shortest pulse width in the focal plane. However, the pulse width of a femtosecond laser disperses as it passes through optics, producing broadened pulse width when the beam exits from an objective. The FV1000MPE laser beam-shaping optics provides dispersion inverse to *one* produced by the microscope's optics (negative chirp) and, thus ideal pulse width for the specimen.

2 Custom light adjustment for the exiting laser beam.

The FV1000MPE comes standard with an AOM to adjust laser light. The AOM allows changes in laser intensity and rapid ON/OFF switching of the laser. This provides laser output control in accordance with specimen brightness, avoiding irradiation to surrounding areas. In thick specimens, laser intensity can be adjusted in accordance with specimen depth allowing image capture without changes in brightness.

3 Auto-adjustment of the beam in accordance with the excitation wavelength and objective.

To achieve efficient multiphoton excitation, the laser beam, described by Gaussian distribution of intensity, must fill the pupil diameter as it enters the objective.

The FV1000MPE with its auto beam expander achieves auto-adjustment of the beam diameter depending on the objective and excitation wavelength. This provides an optimal laser beam for multiphoton excitation microscopy.

Auto beam expander (simplified example)

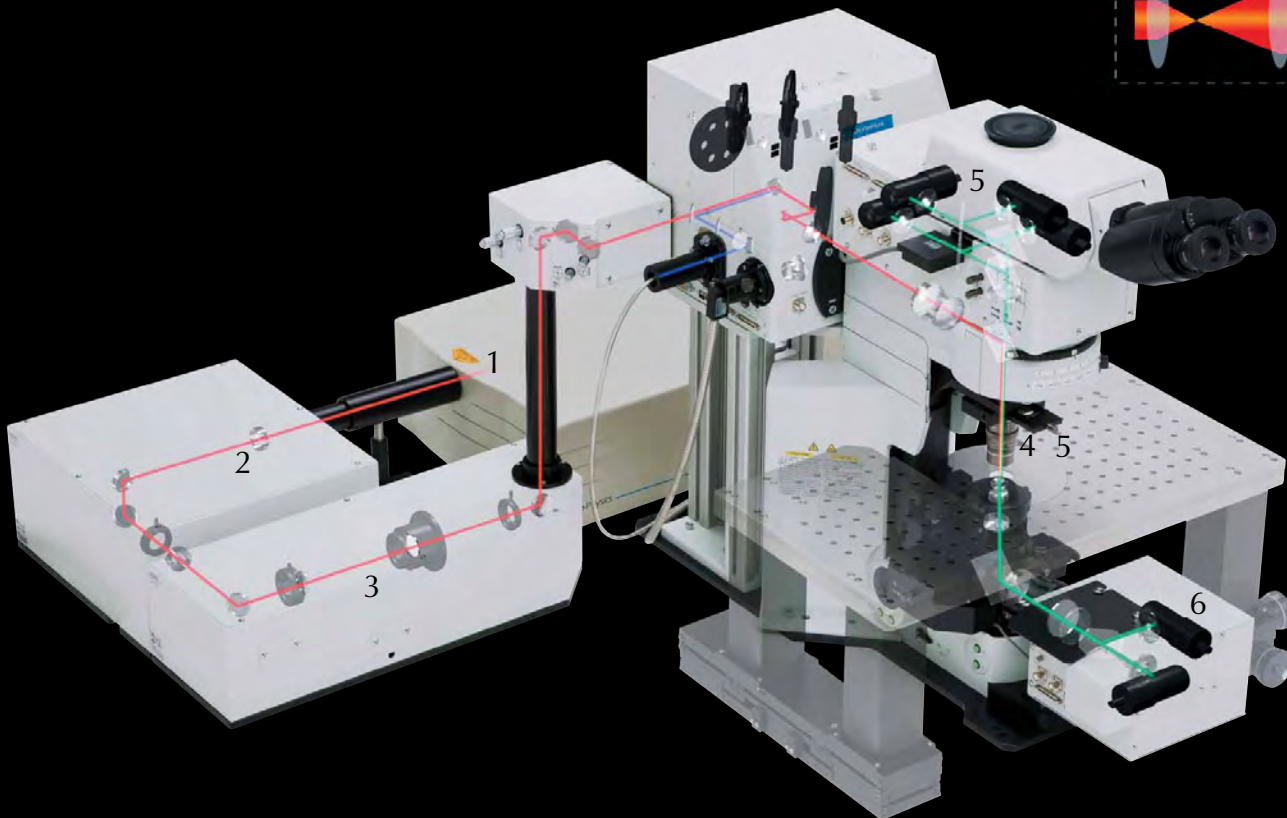
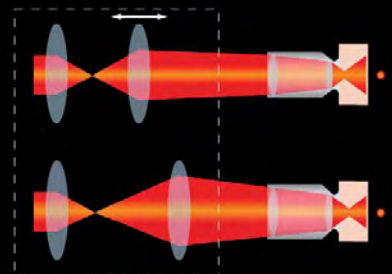

PE allows bright, them.

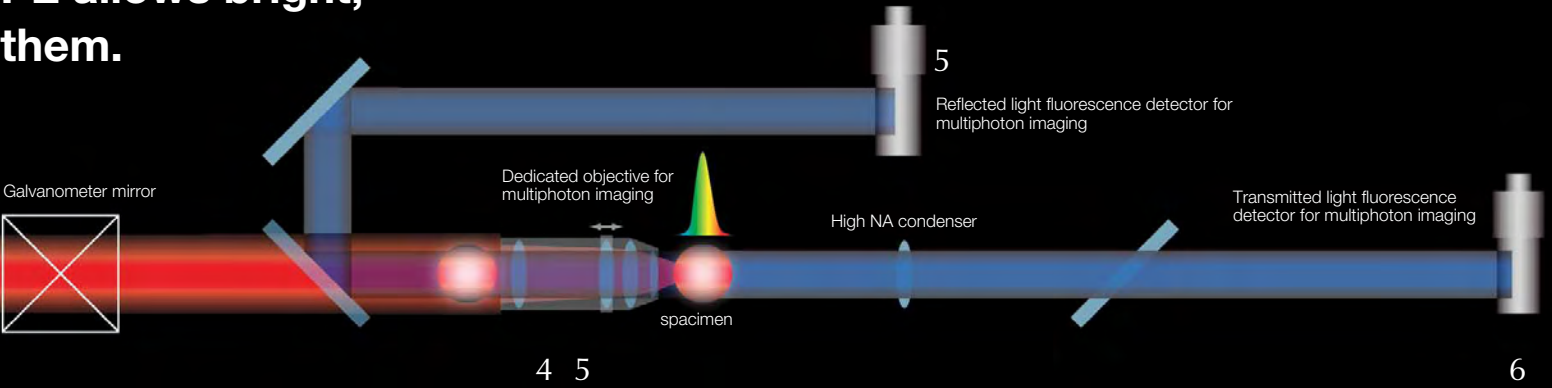

4 Correcting for light refraction in the specimen and providing deep imaging.

Refraction index mismatches within the specimen of itself create a problem in deep imaging by disrupting the focal spot. The FV1000MPE's dedicated objective compensates the refractive index differences thanks to its correction collar, allowing the formation of an ideal focal spot deep within the specimen without loss of energy density.

5 Widefield design to detect fluorescence with no loss of scattered light.

In multiphoton excitation, fluorescence from the focal spot inside the specimen surface is excited. Live specimens scatter light, and this is linked to a loss of detected fluorescence. With its widefield design, the FV1000MPE can capture the maximum amount of fluorescent signal, along with scattered light, to provide highly efficient fluorescence imaging.

6 Even brighter in-depth observation with transmitted light detection.

A transmitted light fluorescence detector for multiphoton imaging with dedicated high N.A. condenser detects transmitted fluorescence as well as transmitted and fluorescence scattered at the focal point. These additions allow extremely bright fluorescence imaging deep within a live specimen and for second harmonic generation (SHG) images.

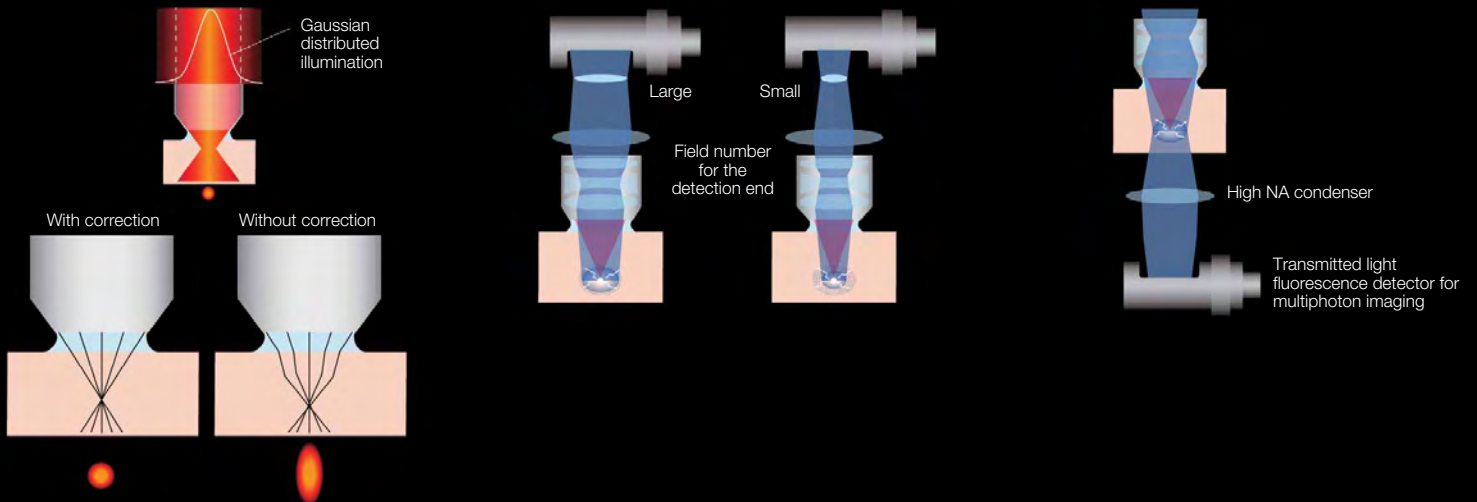

Dedicated objective for multiphoton imaging

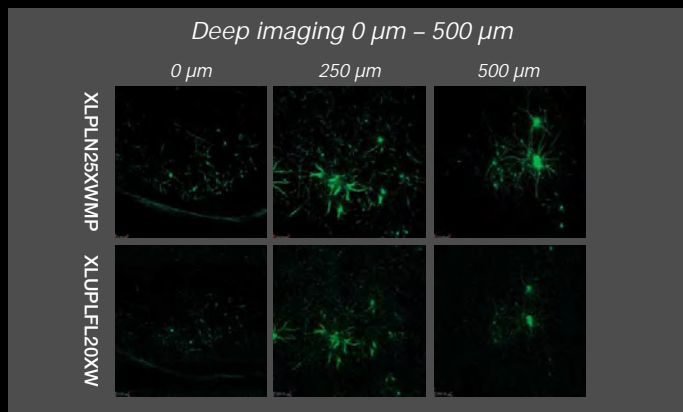

In vivo microscopy images of a mouse (M-Line) brain expressing GFP in cerebral cortex neurons.
Image data provided by: Hiroaki Waki, Tomomi Nemoto, and Junichi Nabekura
National Institute for Physiological Sciences, National Institutes of Natural Sciences, Japan

Multiphoton transmitted light fluorescence observations

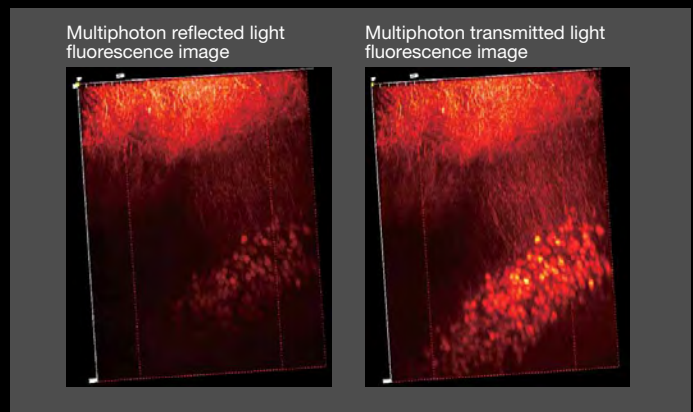

500 μ m thick mouse brain slice specimen observation images.
Specimen provided by: Hiroaki Waki, Tomomi Nemoto, and Junichi Nabekura
National Institute for Physiological Sciences, National Institutes of Natural Sciences, Japan

XLPLN25XWMP, dedicated objective with exceptional brightness and resolution for multiphoton imaging.

This water immersion objective with a high N.A. and widefield design has improved near-infrared transmittance to optimize multiphoton fluorescence microscopy. The objective correction collar minimizes spherical aberration caused by refractive index differences between water and the specimen. This allows formation of a focal spot without reducing energy density during deep imaging. Its widefield design, helping to detect scattered fluorescence in a specimen, allows extremely bright, high-resolution fluorescence microscopy. In addition, it provides an approach angle of 35 degrees while maintaining a high N.A., allowing easy access to execute simultaneous patch clamping and imaging.

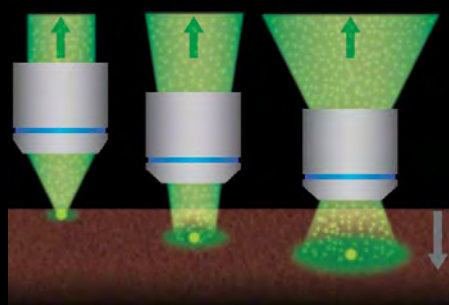

Widefield design.

Despite efficient excitation, fluorescence is scattered deep within the specimen. This widefield objective can collect scattered fluorescence with a high level of efficiency and provides brighter images.

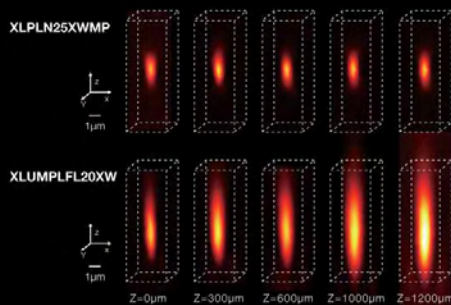

Highly focused light deep within the specimen.

In this example, fluorescent microspheres 0.5 μm in diameter were observed in a highly refractive media. Resolution in the Z-direction has been markedly improved compared to conventional 20X objective.

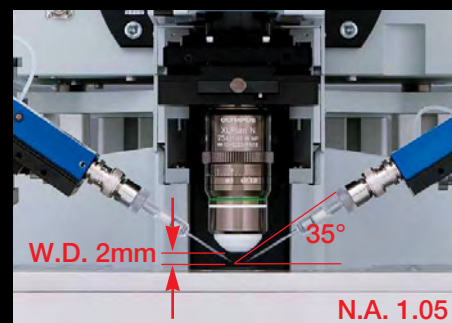

Sharp approach angle.

An approach angle of 35 degrees provides easy access for patch clamping. Use of this dedicated objective for multiphoton imaging allows imaging and patch clamp recordings simultaneously.

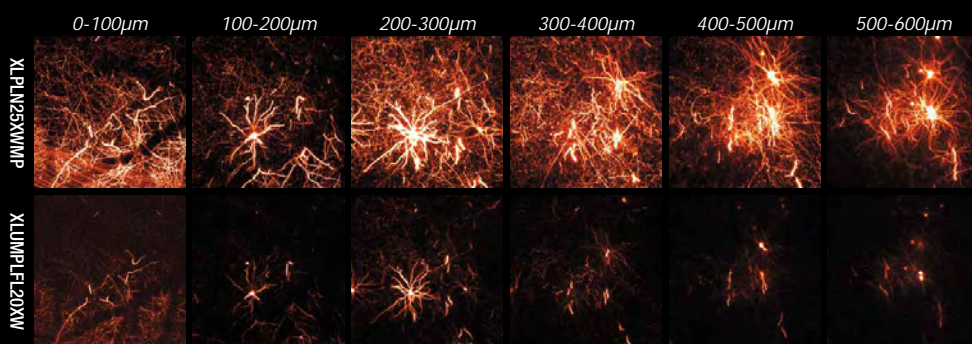

High sensitivity, high resolution.

The power of the XLPLN25XWMP shines particularly in deep imaging. The objective allows extremely bright, high-resolution fluorescence microscopy deep within the specimen that are not readily observed with a conventional water immersion objective.

In vivo microscopy images of a mouse (M-Line) brain expressing GFP in cerebral cortex neurons.

Specimens provided by: Hiroaki Waki, Tomomi Nemoto, and Junichi Nabekura, National Institute for Physiological Sciences, National Institutes of Natural Sciences, Japan

Objectives for BX61WI

	Numerical Aperture	Working Distance (mm)
MPLN5X	0.10	20.0
UMPLFLN10XW	0.30	3.5
UMPLFLN20XW	0.50	3.5
LUMPLFLN40XW	0.80	3.3
LUMPLFLN60XW	1.00	2.0
LUMFLN60XW	1.10	1.5
XLUMPLFL20XW*	0.95	2.0
XLPLN25XWMP*	1.05	2.0
UPLSAPO60XW	1.20	0.28

*Exclusively for BX61WI configuration

Objectives for IX81

	Numerical Aperture	Working Distance (mm)
UPLSAPO10X2	0.40	3.1
UPLSAPO20X	0.75	0.6
UPLSAPO40X2	0.95	0.18
UPLFLN 40XO	1.30	0.2
UPLSAPO60XO	1.35	0.15
LUMFLN60XW	1.10	1.5
UPLSAPO60XW	1.20	0.28

Fluorescence detectors for high-sensitivity multiphoton imaging.

Reflected light fluorescence detector.

Fluorescent signal is not only extremely faint, but also scatters inside a specimen during deep imaging, causing further decay in signal intensity. The FV1000MPE uses a detector installed at a position as close as possible to the specimen in order to maximize detection efficiency. This detector can capture all fluorescent signals without passing through a confocal aperture. This allows imaging with a high level of sensitivity minimizing light losses.

- In addition to the standard 2CH type equipped with 2 photomultipliers, a 4CH type of reflected light fluorescence detector for multiphoton imaging is available. All detectors are located equidistant from the specimen and allow bright, high-sensitivity multicolor imaging.
- Olympus' own high-performance filter is used for wavelength separation. It can be replaced with other filters depending on the fluorescence wavelength of the specimen.

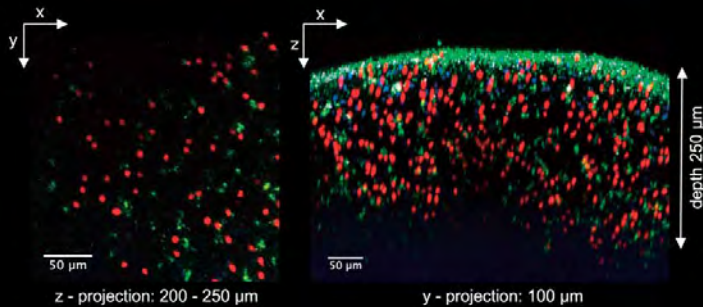

lymphocytes labeled with either SNARF (red) or CMAC (blue).

The transferred cells and autofluorescence (green) can be observed through the collagen rich capsular region to a depth greater than 250 μm . The left panel depicts the z-projection of an image stack between 200 and 250 μm depth. The right panel shows the 100 μm y-projection of the same stack sliced along the xz-plane.

Excitation at 800 nm, objective XLPLN 25XWMP, NA 1.05.

Julia Eckl-Dorna, Patricia Barral, Andreas Bruckbauer, Facundo Batista
Cancer Research UK, London Research Institute, London, UK

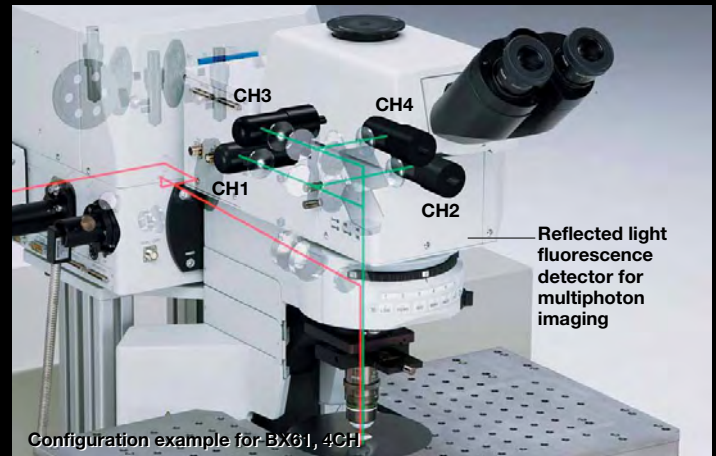

Configuration example for BX81, 4CH

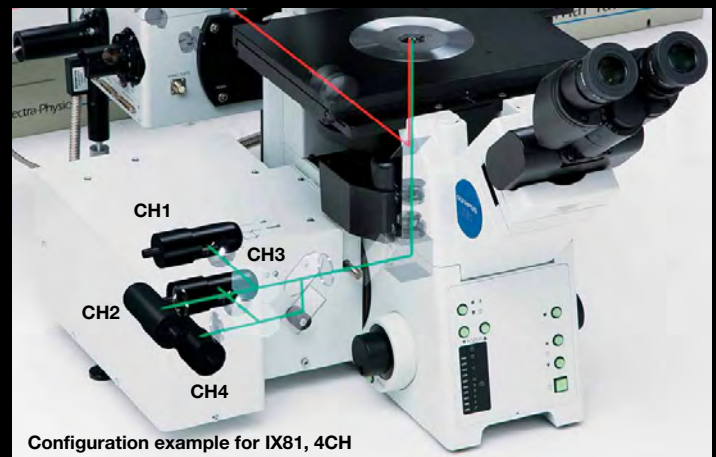

Configuration example for IX81, 4CH

Transmitted light fluorescence detector.

A high N.A. condenser and transmitted light fluorescence detector for multiphoton imaging detect emitted fluorescence in the focal plane and light scattered within the specimen. With this transmitted light detector, fluorescence can be detected with a high level of efficiency, especially in deep layers of the specimen.

- The transmitted light fluorescence detector has 2 channels. These 2 channels can be used to detect fluorescence or SHG. Taking into account the reflected light fluorescence detector, FV1000MPE allows maximum 6-channel simultaneous acquisition.
- Two types of dichromatic mirrors are available: one is a fluorescence collection type for wavelength separation in 2 channels and another for fluorescence and SHG (475 nm).
- Two types of condensers are available: one with an oil top lens for high N.A. (NA 1.45) and another with a dry top lens (NA 0.8).
- Switching between transmitted light fluorescence detection and DIC observation is easy. This is optimal for patch clamping (transmitted light fluorescence detection and DIC observation cannot be performed simultaneously).

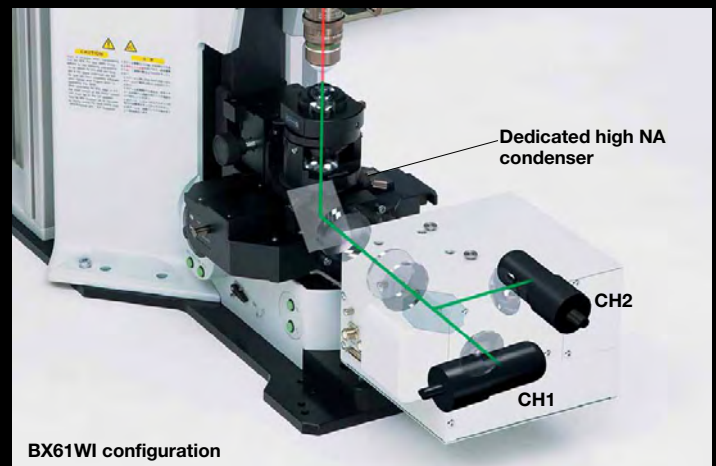

BX61WI configuration



Second Harmonic Generation imaging of neurons.

A: SHG image of neurons in dissociated culture from the mouse cerebral cortex. After FM4-64 was injected to neurons, the cells were irradiated with a femtosecond laser at 950 nm and the SHG signal at 475 nm was detected with the transmitted light detector.

B: Zoomed fragment (5X) of the specimen in the yellow box in image A. As it is apparent, spines protruding from dendrites can be observed with SHG.

C: SHG and multiphoton images have been superimposed.

Image data provided by:
Mutsuo Nuriya, PhD, Masato Yasui, MD, PhD
Department of Pharmacology School of Medicine, Keio University

Application of multiphoton microscopy to laser light stimulation.

Multiphoton simultaneous imaging and laser stimulation.

Laser light stimulation can be adjusted as desired without the user being limited by imaging settings. This is due to the independent FV1000's second scanner (SIM) used for laser light stimulation (available as an option). Connected to SIM-scanner, the second multiphoton laser provides simultaneous stimulation at the same focal plane that is used for imaging.

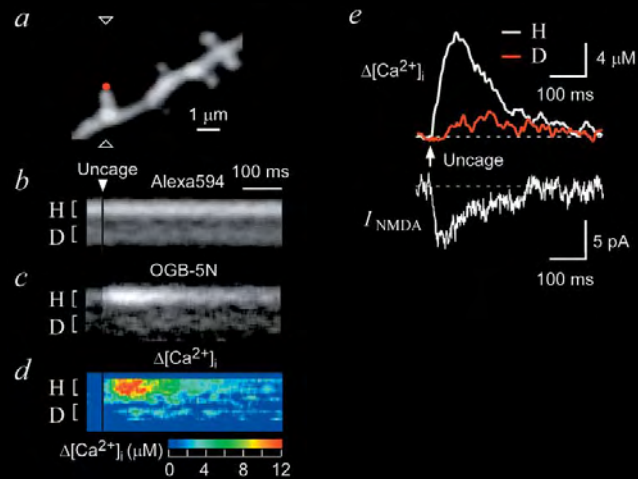

Calcium signal of a single dendritic spine examined by multiphoton uncaging and fluorescence
 a) Stacked fluorescent image of dendritic spines in the hippocampus (excitation of 830 nm). Whole-cell recording was performed. Alexa 594 and the calcium indicator OGB-5N were injected. At the head of the single spine (red), multiphoton uncaging of caged glutamate was done and glutamate was injected (excitation of 720 nm). A line scan was performed on the line (the line linking the 2 triangles) from the head of this single spine toward the dendritic trunk.
 b), c) Simultaneous line scanning for Alexa 594 and OGB-5N.
 d) Calcium concentration determined from the fluorescence emission ratios of OGB-5N and Alexa 594.
 e) Changes in calcium concentration at the head of the spine (H, black), changes in calcium concentration at the dendritic trunk (D, red), current from whole-cell recorded NMDA receptors (INMDA). Calcium flow into the trunk via NMDA receptors at the head of the spine is apparent from these observations.

Reprinted from Noguchi et al. Neuron 46(2005)609-622.

Jun Noguchi, Haruo Kasai
 Center for Disease Biology and Integrative Medicine, Faculty of Medicine,
 University of Tokyo

Synchronization of laser light stimulation and patch clamp signals.

The FV1000MPE's analog unit enables voltages to be converted into images and handled just like fluorescence images. For example, electrical signals measured by patch clamping during laser light stimulation can be synchronized with the image acquisition and displayed with pseudo color.

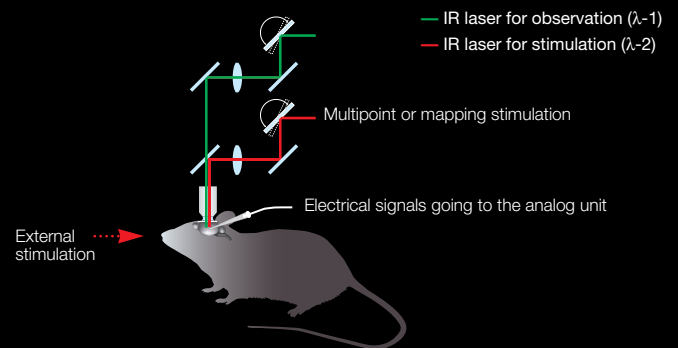

Laser light mapping and multipoint stimulation.

The observation field is divided into a grid and separate fields are discretely irradiated with a laser, allowing laser light stimulation while excluding the signal influence from adjacent fields. The mapping & multipoint software enables auto stimulation at multiple points (optional software).

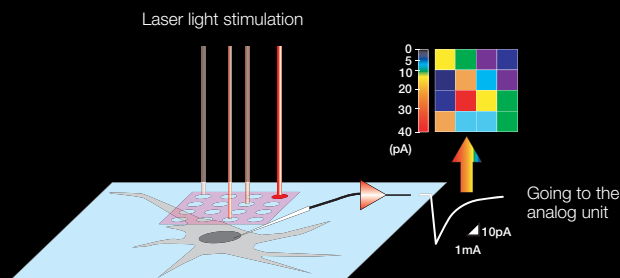

A typical combination of laser light stimulation and an analog unit

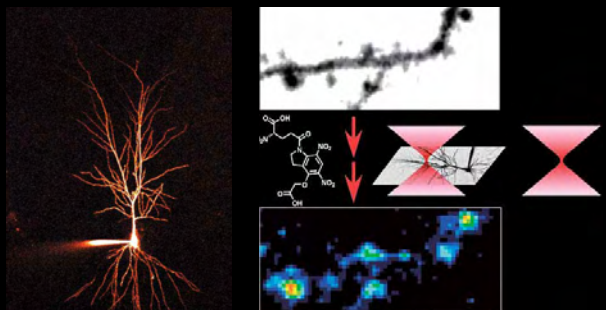

Functional mapping of glutamate receptors at the single spine level via multiphoton excitation of caged glutamate.

Left: Stacked multiphoton fluorescence images (excitation of 830 nm, Alexa594 as fluorochrome) of hippocampal CA1 pyramidal cells.

Top right: An enlargement of the mapping field.

Bottom right: Electrical signals from glutamate receptor current, obtained with whole-cell recording. The separate points in the top right figure are irradiated with the laser, captured and then mapped with color-coding to represent the values of cell response. At that point, caged glutamate (CDNI-glutamate) is then injected to specimen slices.

Image data provided by:
 Masaki Matsuzaki, Haruo Kasai
 Center for Disease Biology and Integrative Medicine, Faculty of Medicine, University of Tokyo

Broad range of features to meet various experimentation needs.

Software features.

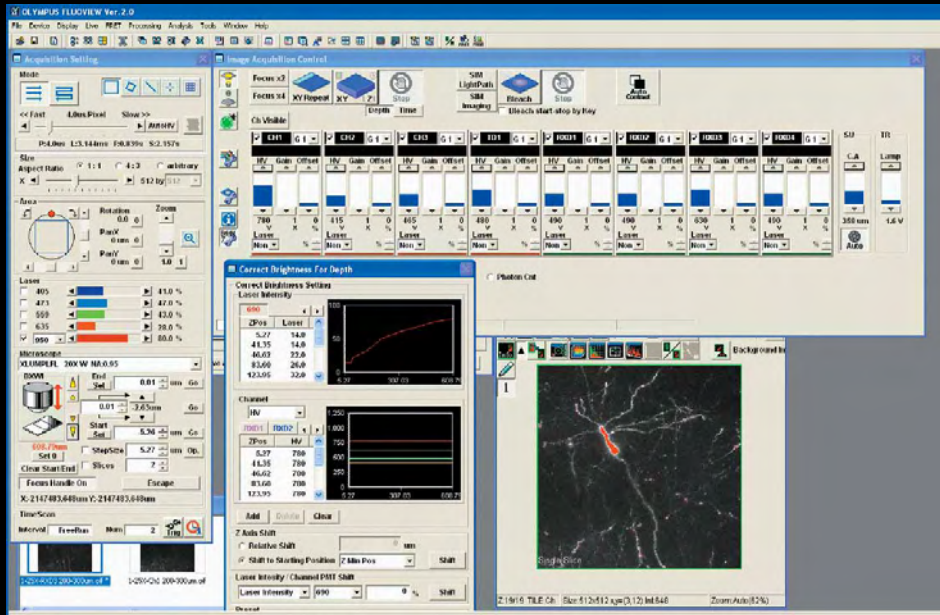

•Wide choice of scan modes.

The FV1000MPE comes with AOM as standard and provides fine position and time control of imaging and light stimulation. Using Olympus' own tornado scanning allows rapid bleaching and laser light stimulation of desired fields in experiments like those involving FRAP and uncaging.

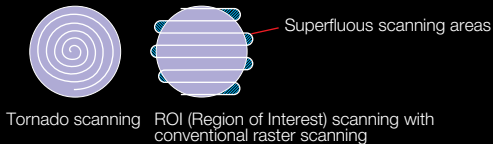

•The Time Controller for highly customizable time-lapse experiments

Fully automatic experiments for both imaging and laser stimulation are designed with and performed by the Time Controller. During observation, image acquisition conditions are imported and reflected in the Time Controller. Experimental parameters are set just by clicking or dragging the mouse, thus even complex experimental protocols can easily be performed.

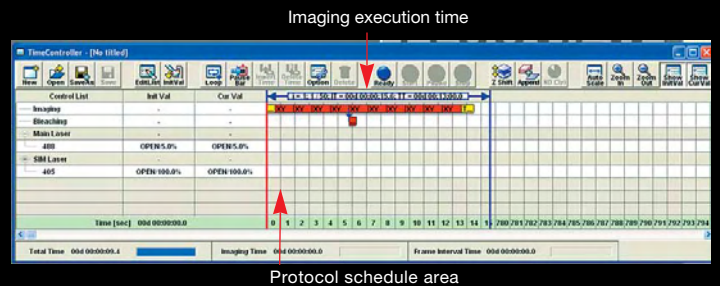

•Brightness compensation function in the Z direction.

The images brightness when imaging deeper into a thick specimen. Use of this function enables changing the detector sensitivity and laser power while continuously acquiring an image to match the focal position, thus allowing high-sensitivity and high-precision imaging without losing information from the thick portion of the specimen.

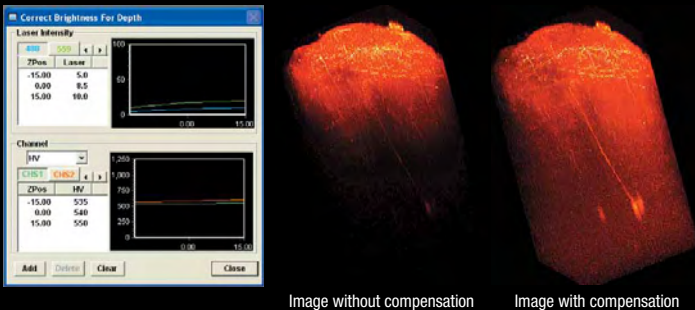

•Multichannel display

In addition to normal confocal images, the FV1000MPE can simultaneously capture data from the reflected light fluorescence detector (maximum of 4CH), transmitted light fluorescence detector (maximum of 2CH) for multiphoton imaging, and analog signals (maximum of 2CH) and convert it into images. Captured images can be optionally displayed, and merged images can be created as desired.

The arm height raising kit enables small animal experiments

The arm height raising kit provides an additional 40mm of clearance and is mounted between the microscope frame and the reflected light illuminator. This facilitates experiments requiring small animals.

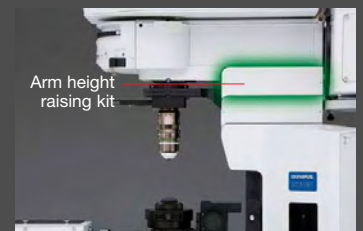

Mouse/Rat brain

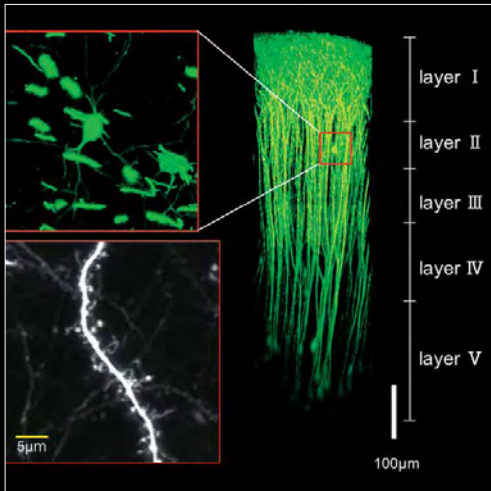

3-dimensionally constructed images of neurons expressing EYFP in the cerebral neocortex of a mouse under anesthesia.

Cross-sectional images down to 0.7 mm from the surface can be observed after attachment of a special adapter to the specimen.

Objective: LUMPlanFL 60XW/IR

Image data provided by:
Hiroaki Waki, Tomomi Nemoto, and Junichi Nabekura
National Institute for Physiological Sciences,
National Institutes of Natural Sciences, Japan

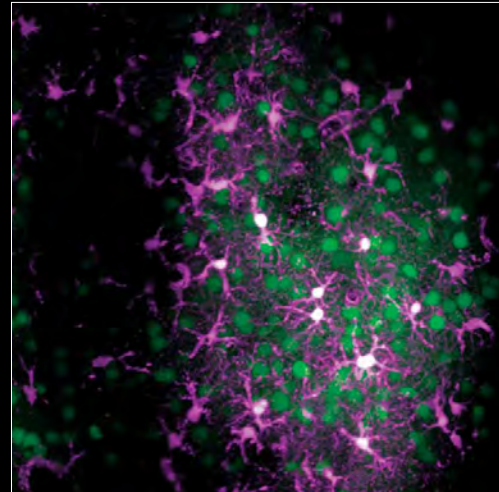

Z-stack image of neurons and glial cells in layers II and III of the cerebral cortex of a rat under anesthesia.

Magenta: glial cells (astrocytes) marked by specific fluorescence marker Sulforhodamine 101, Green: neurons and glial cells, Ca-sensitive fluorescent dye Oregon Green 488 BAPTA-1 200 μm.

Image data provided by:
Norio Takata, Hajime Hirase
Neuronal Circuit Mechanisms Research Group, Riken Brain Science Institute, Japan

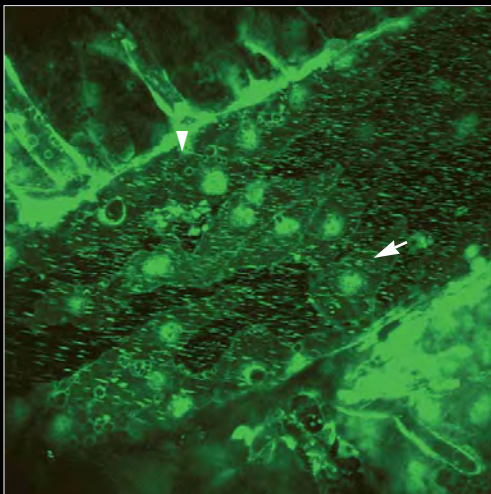

In vivo observation inside the brain of a GFP-actin transgenic mouse.

One hundred and three minutes after a low concentration of lipopolysaccharide was intravenously injected into the mouse, attachments between epithelial cells detached (arrow) and a thrombus formed (triangle).

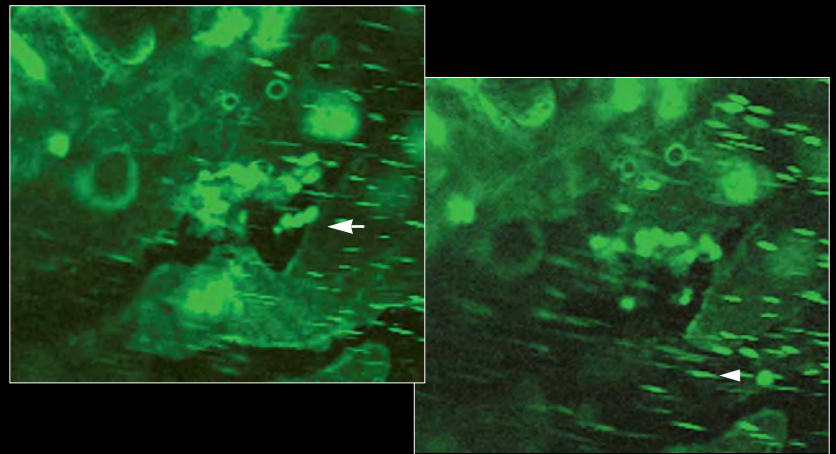

In vivo observation inside the brain of a GFP-actin transgenic mouse.

These images may suggest that after the mouse was injected with a low concentration of lipopolysaccharide, attachments between epithelial cells detached in cerebral blood vessels (arrow in the upper left figure), followed by epithelial cells detaching from the vascular wall (triangle in bottom right figure).

Image data provided by:
Hisako Nakajima, Akira Mizoguchi
Neural regeneration and cell communication, Genomics and regenerative biology,
Mie university graduate school of medicine

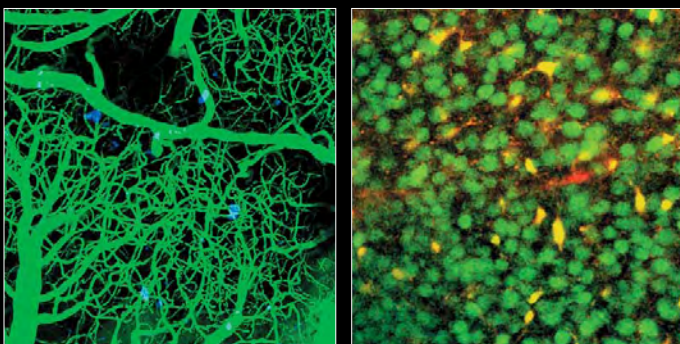

Left: fluorescence angiogram in the brain of a living mouse represented by a maximum intensity projection of the imaging volume of ~600X600X600 microns. The imaging was performed on a transgenic mouse that develops senile plaques similar to those found in case of Alzheimer's disease. They are labeled with the fluorescent compound methoxy-XO4 (blue).

Right: a group of neurons and astrocytes loaded with the intracellular calcium reporter OGB-1 (green). Astrocytes are labeled with SR101 (red). Astrocytes that are loaded with OGB and tagged with SR101 are yellow.

Image data provided by:
Brian J. Bacskai, PhD
Alzheimer's Disease Research Unit, Mass. General Hospital

Mouse retina

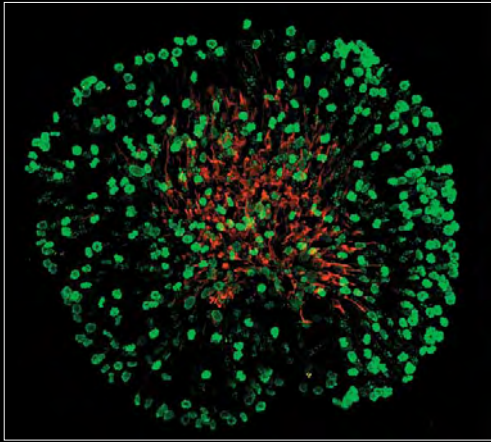

Observation of neurogenesis in the early mouse retina.

Whole-mount specimen of the mouse retina in which mitotic progenitor cells are stained with Alexa488 (green) and neurons are stained with Alexa568 (red). Using this specimen, images were superimposed after about 120 cross sectional images were acquired.

(with XLPLN25XWMP objective and excitation wavelength of 890 nm)

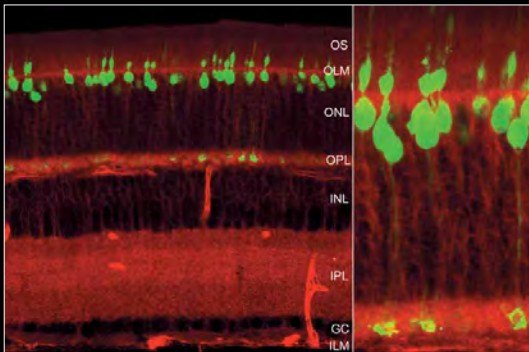

Observation of the retina in which rod photoreceptors were labeled with EGFP (green) and ubiquitous retina cells were labeled with tdTomato (red).

The specimen was fixed for a short period of time, but images were acquired under conditions for live cell imaging (low laser power) (with an XLPLN25XWMP objective and excitation wavelength of 890 nm).

Specimens provided by:

Dr. Branden R. Nelson, PhD at the University of Washington

Mouse spleen

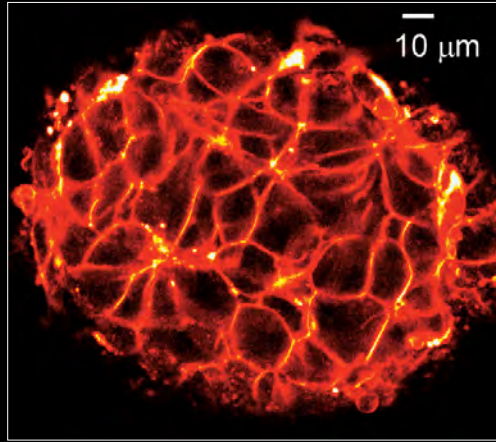

Living pancreatic islet of Langerhans stained with FM1-43 lipid-soluble fluorescent dye. The cell membrane structure of the islet of Langerhans and growth of the membrane area accompanying insulin exocytosis of a single insulin granule can be observed.

Image data provided by:

Noriko Takahashi, Haruo Kasai

Center for Disease Biology and Integrative Medicine, Faculty of Medicine, University of Tokyo

Silkworm

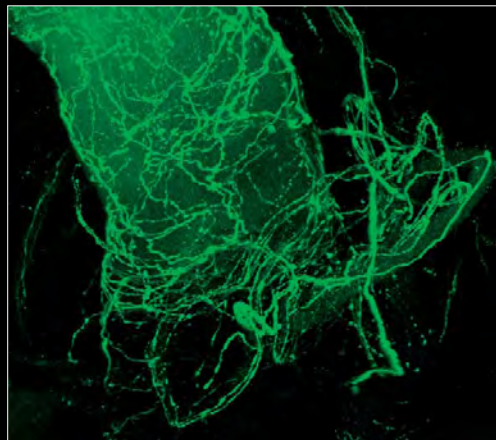

3-dimensionally constructed image of cGMP-containing cells marked with CY3 located along the antenna nerve of the silkworm.

200 μm projection image.

Image data provided by:

Hiroshi Aonuma

Research Institute for Electronic Science, Hokkaido University, Japan

Zebrafish

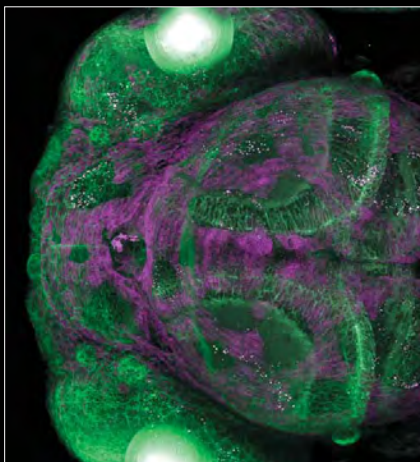
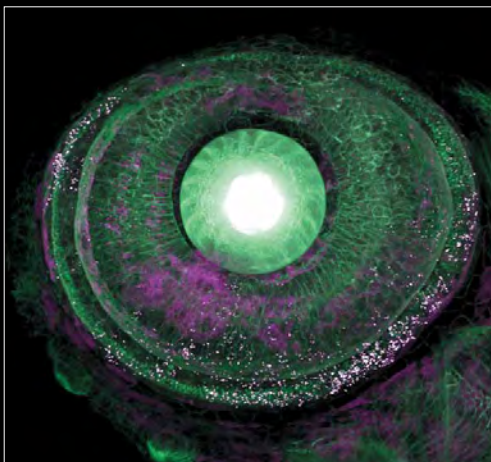

Transgenic zebrafish with cell membranes labeled with CFP.

CFP is shown in green and YFP in magenta.

Image data provided by:

Dr. Rachel O Wong, Mr. Philip Williams,

Dept. Biological Structure, University of Washington

A varied lineup for laser light stimulation and in-depth observation, from *in vivo* to Live Cell imaging.

M system (multiphoton exclusive system)

M scanner multiphoton exclusive system

This multiphoton exclusive system is not equipped with visible light lasers. Simple optics optimized for multiphoton microscopy allow a smaller size, simpler operation, and deeper imaging within the specimen. The system uses a gold-coated galvanometer scanning mirror.

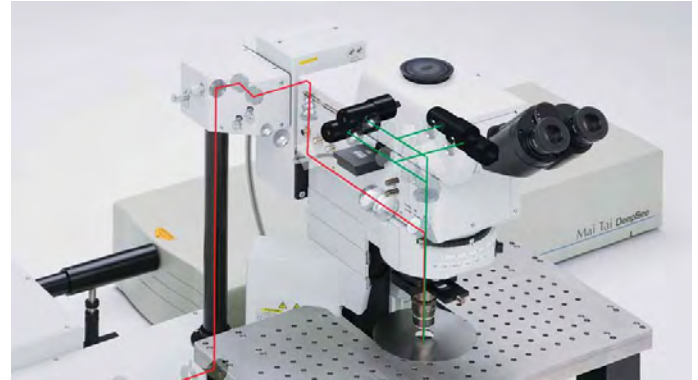

B system (basic system)

Standard scanner multiphoton microscopy system

This system is equipped with an IR laser for multiphoton imaging and laser for visible light, so it is designed for deep imaging by multiphoton microscopy and confocal imaging with a visible laser. The system is designed for a variety of imaging including Live Cell and *in vivo* imaging.

* Using this system along with the double laser combiner allows multiphoton imaging and visible light stimulation.

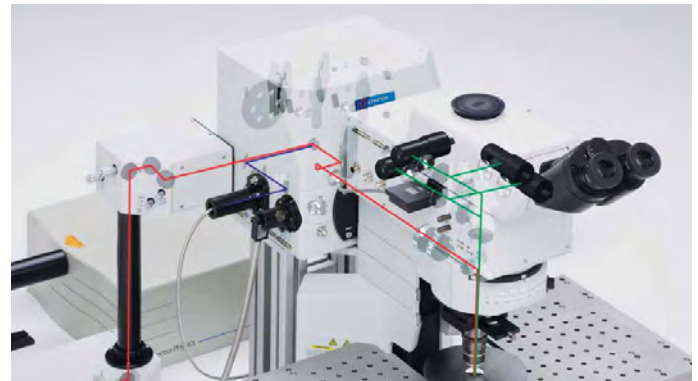

S system (stimulation system)

Multiphoton laser light stimulation system

This system is equipped with an IR laser delivering the light to the scanner for stimulation. In addition to general multiphoton microscopy, the system allows pinpoint light stimulation by multiphoton excitation during imaging with a visible laser.

* Multiphoton microscopy does not allow some image acquisition modes such as Time Controller.

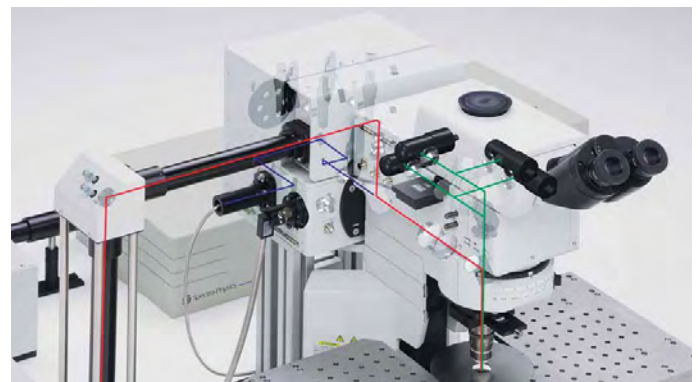

T system (twin system)

Multiphoton microscopy/ multiphoton laser light stimulation system

This system synchronizes laser light stimulation and imaging with 2 independent IR lasers for multiphoton imaging. Laser light stimulation is done with a multiphoton laser, allowing pinpoint stimulation of areas deep within a specimen that cannot be reached with single photon excitation, e.g. stimulation of single dendritic spine. Laser light stimulation can be performed in 3 dimensions or locally at specific sites.



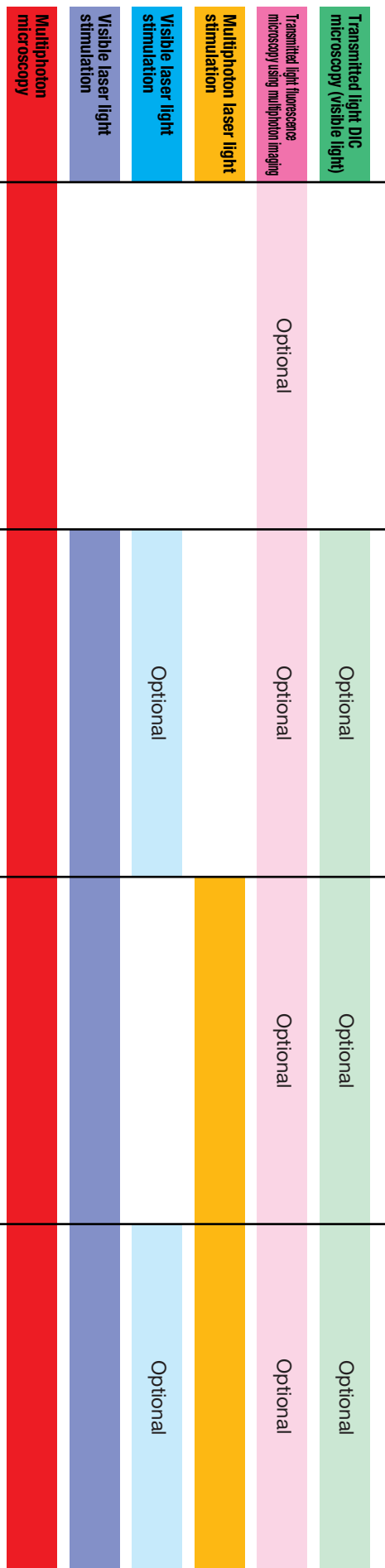

Optics adapted following lasers

The MaiTai BB/HP DeepSee (from Spectra-Physics, a unit of Newport Corporation), used with the FV1000MPE, is equipped with negative chirp in the laser itself.



Manufacturer	Model	Wavelength covered
Spectra-Physics	MaiTai BB DeepSee-OL	710 nm — 990 nm
	MaiTai HP DeepSee-OL	690 nm — 1040 nm

Lasers used along with visible laser light imaging

The multi-combiner enables combinations with all the following diode lasers: 405nm, 440nm, 473nm, 559nm and 635nm. The system can also be equipped with conventional Multi-line Ar laser and HeNe-G laser.



Double type

The multi-combiner outputs laser light with two fibers. Light can be used for both observation and laser light stimulation.



Single type

Single channel laser for visible light observation. AOTF is standard equipment.

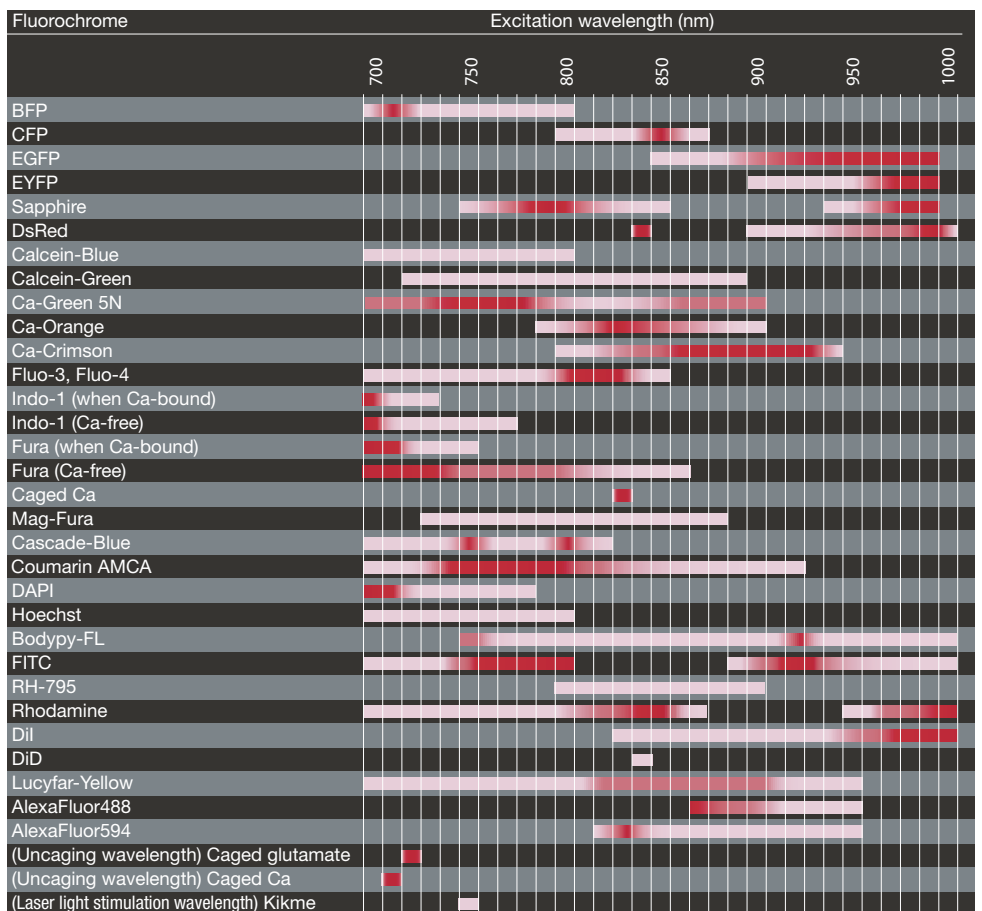

References

Xu, C. and W. W. Webb, J. Opt. Soc. Am. B 13 (3), 481-491, 1996.
 Xu, C., W. Zipfel, J.B. Shear, R.M. Williams and W.W. Webb, PNAS 93(20), 10763-10768, 1996
 Xu, C., R.M. Williams, W.R. Zipfel and W.W. Webb, Bioimaging 4(3), 198-207, 1996
 Heikal, A.A., S.T. Hess, G.S. Baird, R.Y. Tsien and W.W. Webb, PNAS97(22), 11996-12001, 2000

System layout examples

M system (multiphoton exclusive system)

Multiphoton exclusive system, BX61/IX81 configuration

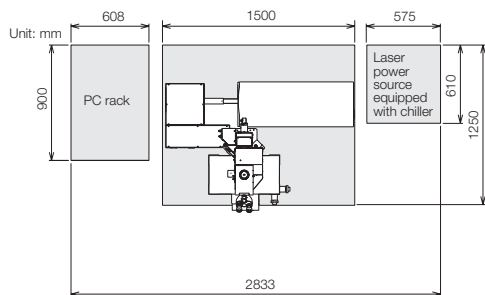

B system (basic system)

Basic system, BX61/IX81 configuration

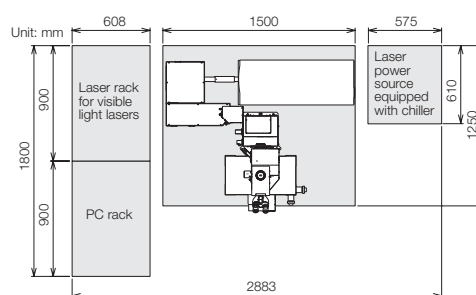

S system (stimulation system)

Stimulation system, BX61/IX81 configuration

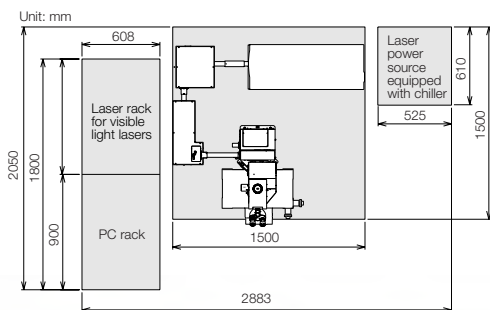

T system (twin system)

Twin system, BX61/IX81 configuration

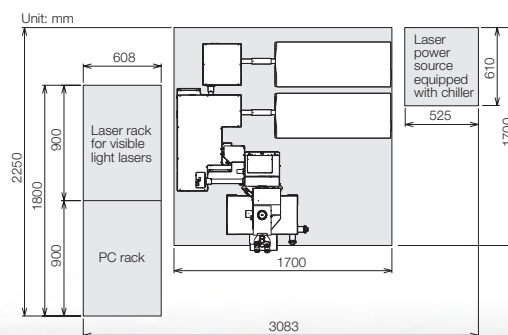

B system
Basic system IX81 configuration

B system
Basic system BX61WI configuration

Multiphoton principle

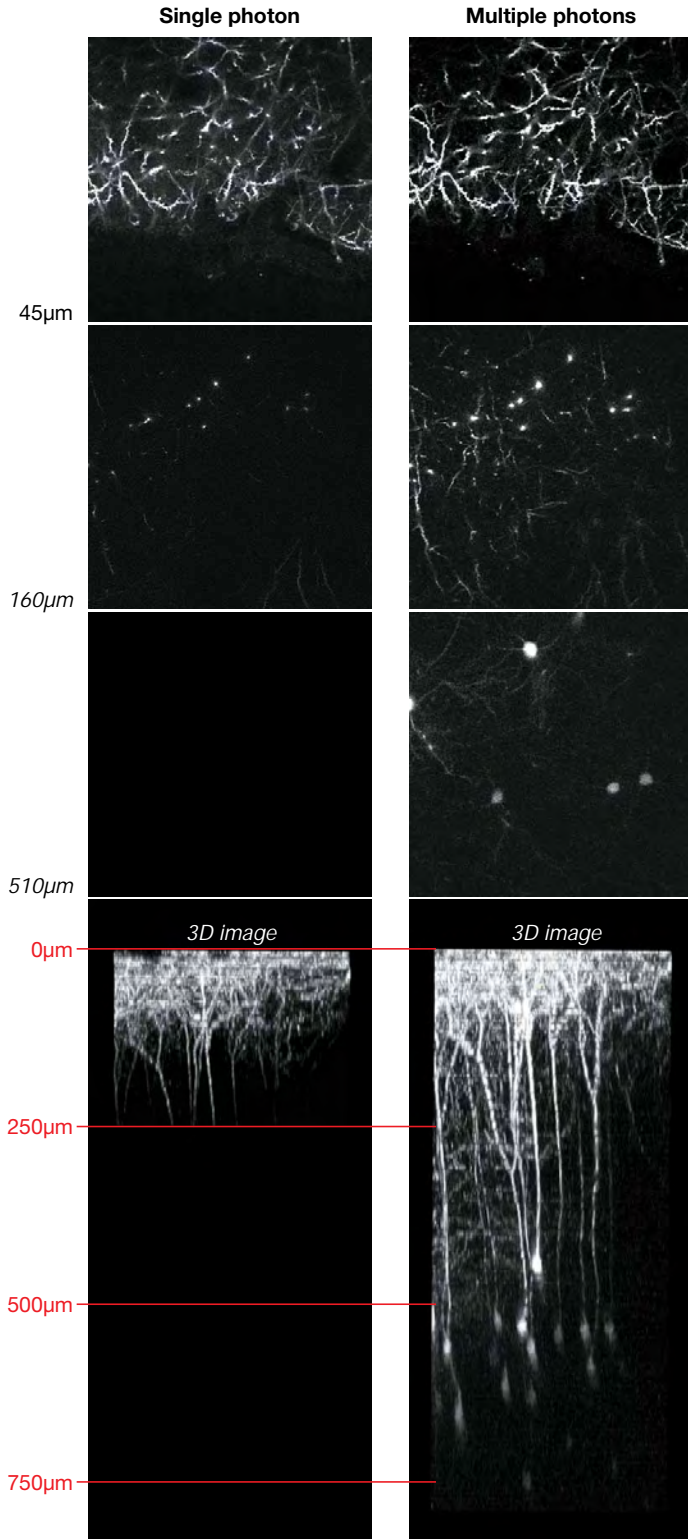

The cerebral cortex of M-line, a strain of transgenic mouse (GFP), was exposed and *in vivo* Z-stack imaging was performed with excitation at 488 nm for single photon excitation and with excitation at 920 nm for multiple photons. With single photon, depths to only 250 µm can be observed, but with multiple photons depths to about 750 µm can be observed.

Images were acquired at a Live cell imaging seminar (National Institute of Advanced Industrial Science and Technology, Tsukuba Research Center).

Specimens provided by:
 Kimihiko Kameyama, Tomoyo Ochiishi, Kazuyuki Kiyosue, Tatsuhiko Ebihara
 Molecular Neurobiology Group, Neuroscience Research Institute,
 National Institute of Advanced Industrial Science and Technology, Japan

Multiphoton excitation

A laser radiates high-density light at wavelengths up to several times longer than the emission wavelength, exciting the fluorescence of molecules located exactly at the focal point only. Confocal-type optical sectioning can be achieved without the use of a pinhole, since light is not emitted from areas outside the focal plane.

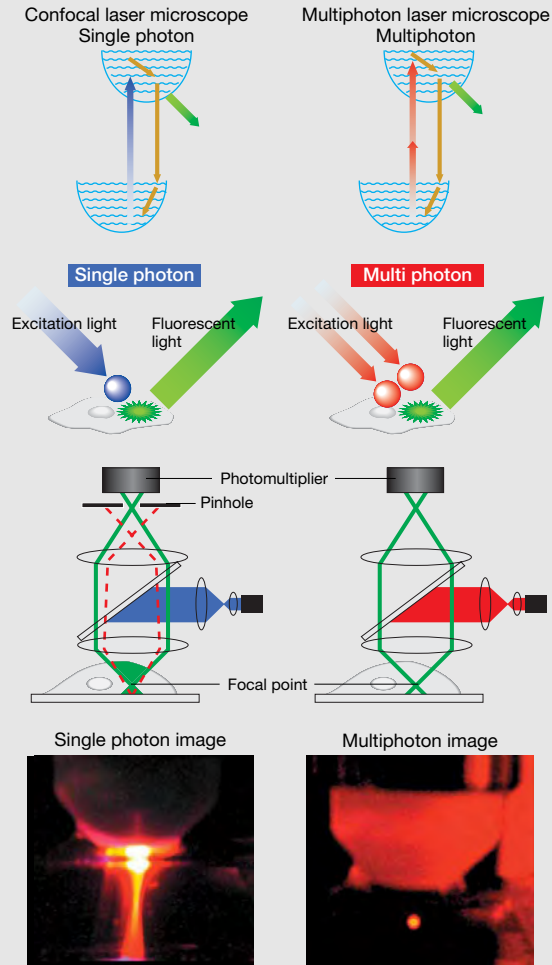

Tomomi Nemoto
 National Institute for Physiological Sciences,
 National Institutes of Natural Sciences, Japan
 Haruo Kasai
 Center for Disease Biology and Integrative Medicine,
 Faculty of Medicine, University of Tokyo, Japan

What is Second Harmonic Generation (SHG)?

SHG is a secondary nonlinear optical phenomenon. In SHG, the energy of 2 photons entering a specimen is combined, producing energy in the form of light. That is, the wavelength of light observed is half of the incident wavelength (the frequency is doubled). An SHG signal is not produced unless molecules in the material are noncentrosymmetric (i.e. a center of inversion symmetry is absent). The signal is linear, so a transmitted light detector is needed. In addition, SHG signal intensity is proportional to the size of the potential, so changes in membrane potential in the vicinity of lipid bilayers of cells with a regular molecular structure can also be analyzed.

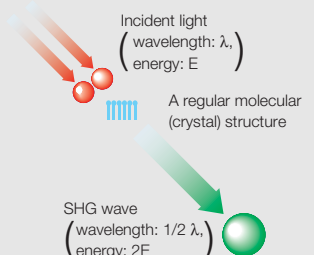

FV1000MPE specifications

		B system	S system	T system	M system	
Laser unit	IR pulsed laser with negative chirp for multiphoton excitation	<ul style="list-style-type: none"> Mode-locked Ti:sapphire laser [femtosecond laser (equipped with a group velocity dispersion correction/control device)], laser power unit, water-cooled circulating chiller MaiTai BB DeepSee-OL or MaiTai HP DeepSee-OL (Spectra-Physics products) MaiTai BB DeepSee-OL: 710 nm — 990 nm MaiTai HP DeepSee-OL: 690 nm — 1040 nm 				
	Visible light laser AOTF laser combiner	LD laser: 405nm: 50mW, 440nm: 25mW, 473nm 15mW, 559nm 15mW, 635nm 20mW Multi Ar laser (458 nm, 488 nm, 515 nm, Total 30 mW), HeNe (G) laser (543 nm, 1 mW) Modulation: Continuously adjustable via an AOTF (0.1 — 100% in 0.1% increments) <ul style="list-style-type: none"> Operating mode: Allows laser turn-off during the retrace period REX: adjustment of laser power for each region, and selection of the laser and selection of the laser wavelength Visible light laser platform with implemented AOTF system, ultra-fast intensity with individual laser lines, additional shutter control, Connected to scanner via single-mode fiber Equipped with laser feedback mechanism to limit changes in laser light intensity over time 			/	
	Single laser for visible light	LD473 laser (15mW) Depending on the type of modulation: light intensity modulation, shutter control, corrected to the scanner via single-mode optical fiber				
Scanning unit	Scanning method	•Light deflection via 2 galvanometer scanning mirrors				
	Scanning modes	<ul style="list-style-type: none"> Pixel size: 64 x 64 — 4096 x 4096 pixels Scanning speed: (pixel time): 2 μs — 200 μs High-speed scanning mode: 16 frames/s (256 x 256) Dimensions: Time, Z, (wavelength) (or any combination thereof) •Line scan: straight line (includes rotation), free line, point XY scan 				
	Zoom size	Observation position zoom with inclination width modification of galvanometer mirror: 1—50X (adjustable in 0.1X increments)				
	Confocal detector (The M scanner does not have a confocal detector)	<ul style="list-style-type: none"> Detector: 3 channels for fluorescence detection (photomultipliers), optional 4CH detector for expansion Dichromatic mirrors for excitation, dichromatic mirrors for multiphoton excitation, dichromatic mirrors for fluorescence, emission filter Infrared cut filter: using a high-performance filter A filter or spectral type of fluorescence detector can be selected Spectral type: Channels 1 and 2 provided with independent grating and slit Selectable wavelength range: 1 – 100 nm, wavelength resolution: 2 nm, wavelength switching speed: 100 nm/ms Pinhole: Single motorized pinhole, pinhole diameter: ø50 – 800μm (spectral type ø50 – 300μm), adjustable in 1 μm increments Field Number: 18 			/	
Optics with infrared laser for multiphoton imaging	<ul style="list-style-type: none"> Integrates a multiphoton near-infrared pulsed laser in the scanning unit (Laser safety measures implemented) Continuously variable output using AOM (0.1 – 100%, 0.1% increments) 					
Component incorporating the laser for multiphoton imaging		Main scanner for observation	ASU scanner for laser light stimulation, Main scanner for observation: VIS laser	Incorporating 2 independent lasers for laser light stimulation/observation	M scanner for observation	
Detector for multiphoton imaging	Reflected light fluorescent detector	Photomultiplier (2 or 4 channels), Fluorescence wavelength can be selected with the dedicated filter cube (replaceable)				
	Transmitted light fluorescent detector	Photomultiplier (2 channels), Fluorescence wavelength can be selected with the dedicated filter cube (replaceable) (not combinable with IX-SVL2) Exclusive equipment for the BX61WI upright microscope				
Transmitted DIC unit	<ul style="list-style-type: none"> Integrated transmitted light detector and transmitted illuminator, Motorized switching Connected to microscope via fiber cable (IR-DIC observation using an infrared laser is not possible) 					
Z-drive	<ul style="list-style-type: none"> A motorized focus module inside the microscope is used Minimum increment: 0.01μm 					
Microscope	Upright microscopes: BX61WI, BX61 Inverted microscope: IX81					
System control	<ul style="list-style-type: none"> OS: WindowsXP Professional (English version), WindowsVista (English version) •CPU: Core2Duo 2.33GHz •Memory: 2.0GB or larger Hard disk: 320GB or larger •Dedicated I/F board: built-in PC •Graphics board: Open GL-compliant Recording media: Equipped with DVD dual drive 					
Software	FV10-ASW Ver.2.0 or later					
Required installation environment	Room temperature: 25°C ± 1°C, humidity: 60% or less@25°C, dust level: Class 10000, requires continuous (24-hour) power supply					
Vibration isolation table for microscope and laser installation, size	1500 mm x 1250 mm	1500 mm x 1500 mm	1700 mm x 1700 mm	1500 mm x 1250mm		



The use of lasers with SUB-PICOSECOND pulses for two-photon microscopy is protected by US Pat No. USP5034613, JP Pat No. JP2848952B2, EU Pat No. EP500717B2, EU Pat No. EP807814B1. This technology is under a license from Carl Zeiss MicroImaging GmbH and Cornell Research Foundation Inc. Performance and safety are no longer guaranteed in the event this product is disassembled or modified.

Cover page image data provided by:
Kei Eto, Hiroyuki Inada, Yusuke Takatsuru, Hiroaki Waki, Tomomi Nemoto, and Junichi Nabekura
National Institute for Physiological Sciences, National Institutes of Natural Sciences, Japan

OLYMPUS CORPORATION has obtained ISO9001/ISO14001

Illumination devices for microscope have suggested lifetimes. Periodic inspections are required. Visit our Website for details.

Specifications are subject to change without any obligation from the manufacturer.

OLYMPUS

OLYMPUS CORPORATION
Shinjuku Monolith, 3-1, Nishi Shinjuku 2-chome, Shinjuku-ku, Tokyo, Japan
OLYMPUS AMERICA INC.
3500 Corporate Parkway, Center Valley, Pennsylvania 18034-0610, U.S.A.

www.olympus.com